

vtech[®]

Instruction Manual

SWITCH & GO[®]

**HATCH & ROAAAAR EGG
TRICERATOPS RACE CAR™**

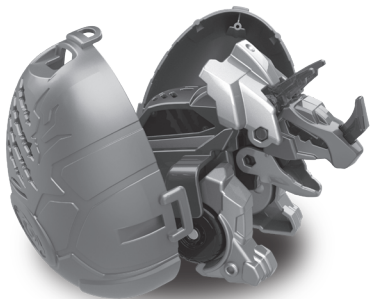

INTRODUCTION

Thank you for purchasing **Switch & Go® Hatch & Roaaar Egg Triceratops Race Car™**.

Assemble this powerful Triceratops, then transform it in a few simple steps into a super cool Race Car. Ready to smash and crash? Here we go!

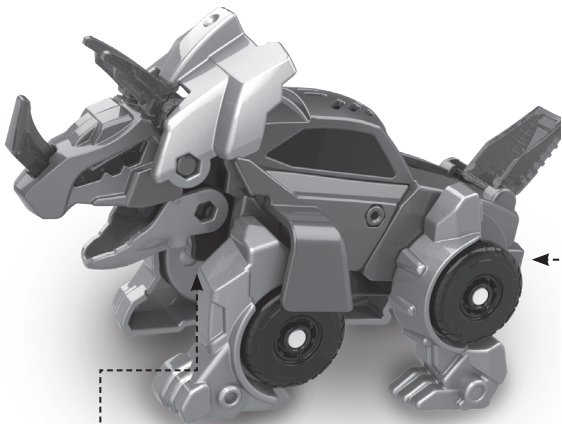

Off / Dino Mode /
Vehicle Mode Switch



Talk Button

INCLUDED IN THE PACKAGE

- **Switch & Go® Hatch & Roaaar Egg Triceratops Race Car™**
- 15 Pieces for Assembly
- Quick Start Guide

WARNING

All packing materials such as tape, plastic sheets, packaging locks, removable tags, cable ties, cords and packaging screws are not part of this toy, and should be discarded for your child's safety.

NOTE

Please save this manual as it contains important information.

ATTENTION

Pour la sécurité de votre enfant, débarrassez-vous de tous les produits d'emballage tels que rubans adhésifs, feuilles de plastique, attaches, étiquettes, cordons et vis d'emballage. Ils ne font pas partie du jouet.

NOTE

Il est conseillé de sauvegarder ce manuel d'utilisation car il comporte des informations importantes.

Unlock the Packaging Locks:

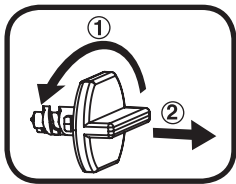

- ① Turn the packaging lock counterclockwise several times.
- ② Pull out the packaging lock and discard.

GETTING STARTED

Exit Try-Me Mode:

The product is in try-me mode in the packaging. To exit try-me mode, just slide the Off/Dino Mode/Vehicle Mode Switch from Vehicle mode to Dino mode/Off.

Battery Removal and Installation

1. Make sure the unit is turned **Off**.
2. Find the battery cover located on the bottom of the unit. Use a screwdriver to loosen the screw, and then open the battery cover.
3. Remove the old battery by pulling up on one end of the battery.
4. Install 1 new AAA battery following the diagram inside the battery box. (For best performance, alkaline batteries or fully charged Ni-MH rechargeable batteries are recommended.)
5. Replace the battery cover and tighten the screw to secure.

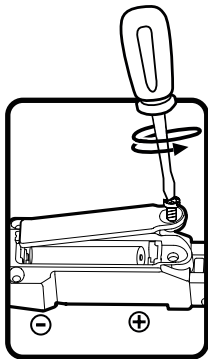

WARNING:

Adult assembly required for battery installation.
Keep batteries out of reach of children.



ATTENTION :

Les piles ou accumulateurs doivent être installés par un adulte.
Tenir les piles ou accumulateurs hors de portée des enfants.

IMPORTANT: BATTERY INFORMATION

- Insert batteries with the correct polarity (+ and -).
- Do not mix old and new batteries.
- Do not mix alkaline, standard (carbon-zinc) or rechargeable batteries.
- Only batteries of the same or equivalent type as recommended are to be used.
- Do not short-circuit the supply terminals.
- Remove batteries during long periods of non-use.
- Remove exhausted batteries from the toy.
- Dispose of batteries safely. Do not dispose of batteries in fire.

RECHARGEABLE BATTERIES

- Remove rechargeable batteries (if removable) from the toy before charging.
- Rechargeable batteries are only to be charged under adult supervision.
- Do not charge non-rechargeable batteries.

IMPORTANT : INFORMATIONS CONCERNANT LES PILES

- Mettre en place les piles ou les accumulateurs en respectant les polarités + et –.
- Ne pas mélanger des piles ou des accumulateurs neufs avec des usagés.
- Ne pas mélanger différents types de piles : alcalines, zinc-carbone et rechargeables.
- Seules des piles du type recommandé doivent être utilisées.
- Ne pas mettre les bornes d'une pile ou d'un accumulateur en court-circuit (en reliant directement le + et le –).
- Retirer les piles ou les accumulateurs en cas de non-utilisation prolongée.
- Enlever les piles ou les accumulateurs usagés du jouet.
- Ne les jeter ni au feu ni dans la nature.

PILES RECHARGEABLES

- Enlever, lorsque c'est possible, les accumulateurs du jouet pour les recharger.
- Les accumulateurs ne doivent être chargés que sous la surveillance d'un adulte.
- Ne pas tenter de recharger des piles non rechargeables.

ASSEMBLY INSTRUCTIONS

1. Identify the following pieces for assembly:

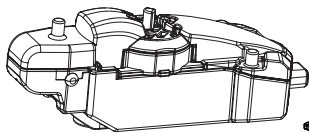

01

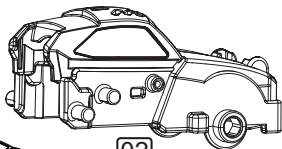

02



03

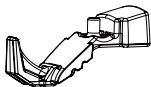

04



05



06



07



08



09

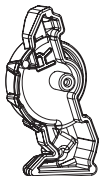

10

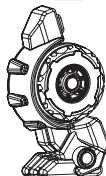

11

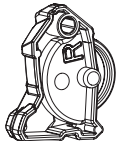

12

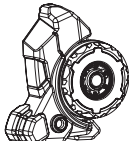

13

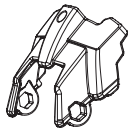

14



15

2. Separately install the A, B, C, D, E, F and G parts as shown in the illustrations.

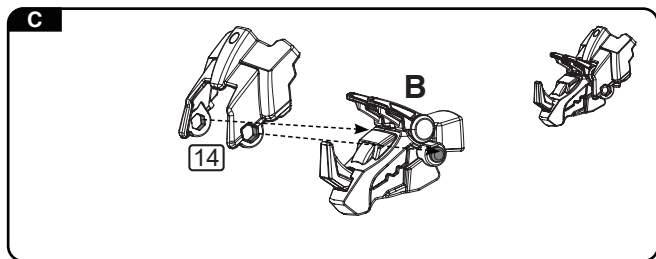
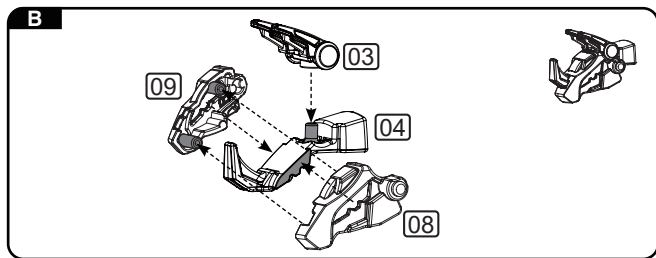
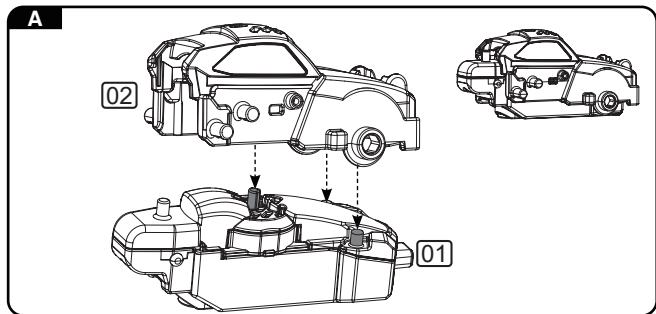

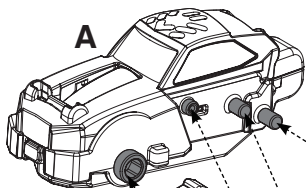
D

10

06

12

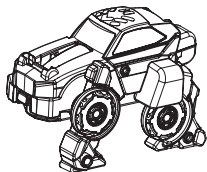
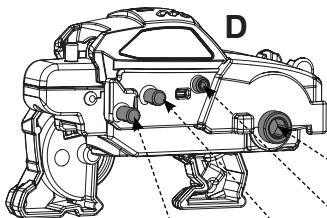
**E**

13

07

11

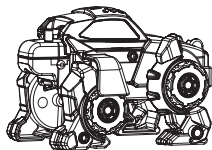

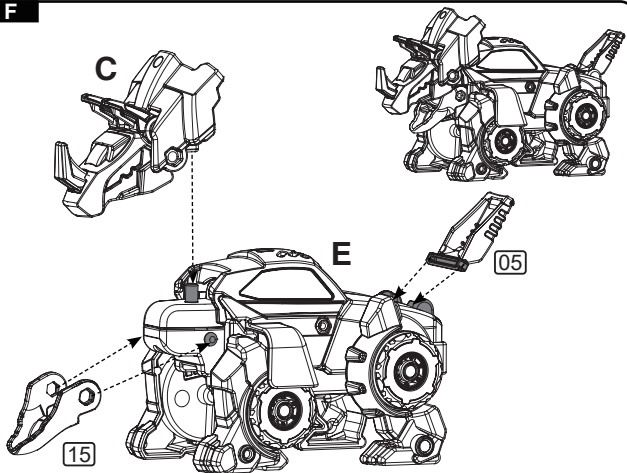
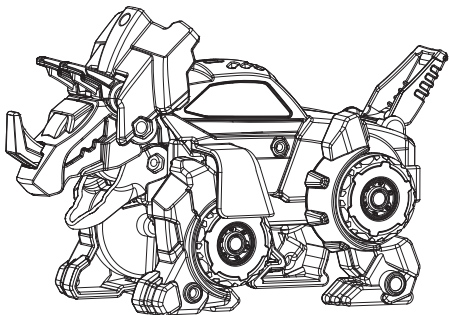
F**G**

TRANSFORMATION

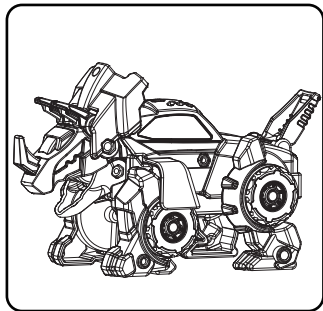

1. Begin in Dino mode.

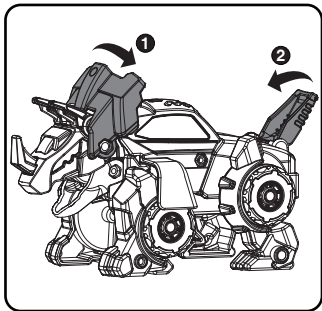

2. Flip down the crest, then flip in the Dino's tail.

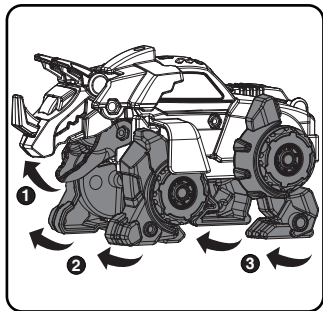

3. Close the Dino's mouth, then flip up the front legs. Next, flip up the back legs.

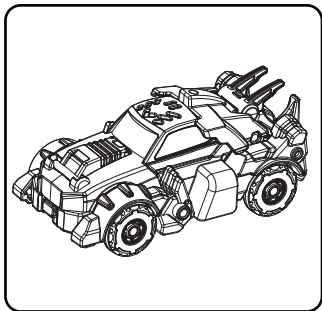



4. The Dino is now changed into a Vehicle. Slide the Off/Dino mode/Vehicle mode Switch to Vehicle mode to play Vehicle responses.

Note: To switch from Vehicle mode to Dino mode, follow the above steps in reverse order.

PRODUCT FEATURES

1. OFF / DINO MODE / VEHICLE MODE SWITCH

Slide the **Off / Dino Mode / Vehicle Mode Switch** to turn the unit **ON** and choose Dino mode() or Vehicle mode() to play. Slide the **Off / Dino Mode / Vehicle Mode Switch** to the **Off** position to turn the unit **OFF**.

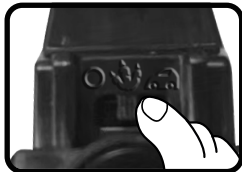

2. Talk Button

Press the **Talk Button** to hear fun phrases and cool dinosaur sounds in Dino mode or hear fun phrases and great vehicle sounds in Vehicle mode.



3. AUTOMATIC SHUT-OFF

To preserve battery life, **Switch & Go® Hatch & Roaaar Egg Triceratops Race Car™** will automatically turn off after a few seconds. **Switch & Go® Hatch & Roaaar Egg Triceratops Race Car™** can be woken up again by pressing the Talk Button, or by switching between Dino and Vehicle modes.

NOTE: If the unit powers down or if the light flashes 3 times without sounds during play, please install a new set of batteries.

CARE & MAINTENANCE

1. Keep the unit clean by wiping it with a slightly damp cloth.
2. Keep the unit out of direct sunlight and away from any direct heat sources.
3. Remove the batteries if the unit will not be in use for an extended period of time.
4. Do not drop the unit on hard surfaces and do not expose the unit to moisture or water.

TROUBLESHOOTING

If for some reason the unit stops working or malfunctions, please follow these steps:

1. Turn the unit **Off**.
2. Interrupt the power supply by removing the batteries.
3. Let the unit stand for a few minutes, then replace the batteries.
4. Turn the unit **On**. The unit should now be ready to use again.
5. If the unit still does not work, replace with a new set of batteries.

IMPORTANT NOTE:

If the problem persists, please call our **Consumer Services Department** at **1-800-521-2010** in the U.S., **1-877-352-8697** in Canada, or visit our website **vtechkids.com** and fill out our **Contact Us** form located under the **Customer Support** link. Creating and developing VTech products is accompanied by a responsibility that we take very seriously. We make every effort to ensure the accuracy of the information, which forms the value of our products. However, errors sometimes can occur. It is important for you to know that we stand behind our products and encourage you to contact us with any problems and/or suggestions you might have. A service representative will be happy to help you.

NOTE

This equipment has been tested and found to comply with the limits for a Class B digital device, pursuant to Part 15 of the FCC Rules. These limits are designed to provide reasonable protection against harmful interference in a residential installation. This equipment generates, uses and can radiate radio frequency energy and, if not installed and used in accordance with the instructions, may cause harmful interference to radio communications. However, there is no guarantee that interference will not occur in a particular installation. If this equipment does cause harmful interference to radio or television reception, which can be determined by turning the equipment off and on, the user is encouraged to try to correct the interference by one or more of the following measures:

- Reorient or relocate the receiving antenna.
- Increase the separation between the equipment and receiver.
- Connect the equipment into an outlet on a circuit different from that to which the receiver is connected.
- Consult the dealer or an experienced radio/TV technician for help.

CAUTION

Changes or modifications not expressly approved by the party responsible for compliance could void the user's authority to operate the equipment.

Supplier's Declaration of Conformity

47 CFR § 2.1077 Compliance Information

Trade Name: VTech®
Model: 5593
Product Name: Switch & Go® Hatch & Roaaar Egg
Triceratops Race Car™
Responsible Party: VTech Electronics North America, L.L.C.
Address: 1156 W. Shure Drive, Suite 200
Arlington Heights, IL 60004
Website: vtechkids.com

THIS DEVICE COMPLIES WITH PART 15 OF THE FCC RULES. OPERATION IS SUBJECT TO THE FOLLOWING TWO CONDITIONS: (1) THIS DEVICE MAY NOT CAUSE HARMFUL INTERFERENCE, AND (2) THIS DEVICE MUST ACCEPT ANY INTERFERENCE RECEIVED, INCLUDING INTERFERENCE THAT MAY CAUSE UNDESIRE OPERATION.

CAN ICES-003(B)/NMB-003(B)



WARNING:

CHOKING HAZARD—Small parts.
Not for children under 3 yrs.



AVERTISSEMENT:

RISQUE DE SUFFOCATION—Petites
pièces. Ne convient pas aux enfants
de moins de 3 ans.

**Visit our website for more
information about our products,
downloads, resources and more.**

vtechkids.com
vtechkids.ca

Read our complete warranty policy online at
vtechkids.com/warranty
vtechkids.ca/warranty

